













Self-contained ice maker - Paddle system
Daily production up to 56 kg

Hotel	██████████
Restaurant	██████████
Fast food	██████████
Bar	██████████
Disco	██████████
Fish market	██████████
Supermarket	██████████
Medical & SPA	██████████
Industry	██████████

► Position n°



► Features & Plus

- Hollow cube
- AISI 304 SS Scotch Brite finish 
- Tropical class +43°C 
- Adjustable Stainless Steel feet
- Removable and cleanable air filter
- Air or water cooling system
- Easy cleanable internal rounded surfaces 
- HCFC-Free insulated storage 
- FDA approved -ABS water basin 
- Basin tipping safety system
- RoHS Free 
- Disappearing insulated door 
- Electromechanical operation 
- ON-OFF rocker switch 
- Automatic water charge
- Standard and special voltages
- HFC Free 



AISI 304 SS Scotch Brite finish



Removable and cleanable air filter



FDA approved - ABS water basin



Disappearing insulated door

► Available ice cube size

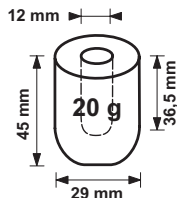

► Prod. 24h

Air temp.	Water temp.		kg	lbs
	10° C	50° F		
10° C	50° F	7° C	56	123
21° C	70° F	15° C	46	101

2 Years Warranty
subject to limitations

► Certifications available for this model





Ice Finger

IMF 58 HC



Self-contained ice maker - Paddle system
Daily production up to 56 kg

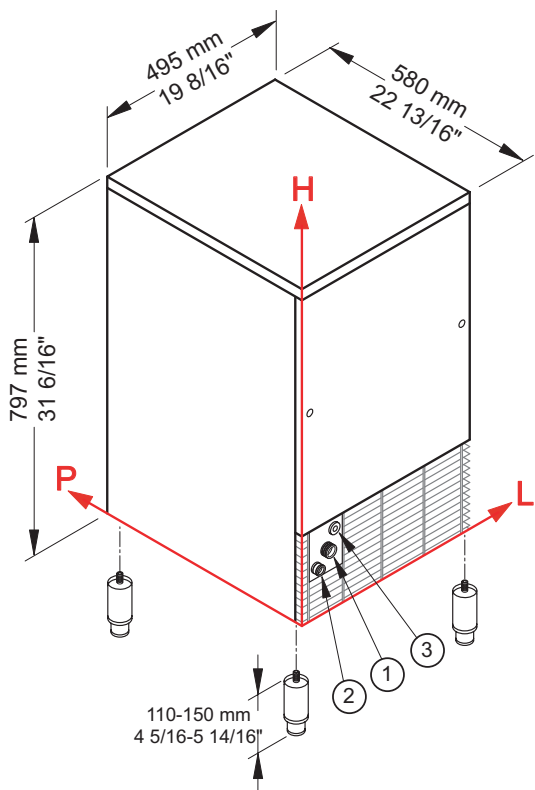

► Working conditions

- Location: **Indoor**

	Min	Max
Ambient temperature	+10° C / +50° F	+43° C / 110° F
Water temperature	+3° C / +37° F	+32° C / +90° F
Voltage	-10%	+10%
Water inlet pressure	1bar (14 psi)	6bar (84 psi)

► Performances

	Air temperature	Water temperature	Water temperature					
			7° C	45° F	15° C	60° F	21° C	70° F
	10° C	56 kg						
	50° F	123 lbs						
	21° C		46 kg					
	70° F			101 lbs				
	32° C				34 kg			
	90° F					75 lbs		

► Connections

All measures are referred to the rear bottom-left corner (L-H-Ø)

- ① Water in.: 111 mm / 4 6/16" - 196 mm / 7 11/16" - 3/4" ② Water out.: 49 mm / 1 15/16" - 151 mm / 5 15/16" - 24 mm / 15/16"
③ Electrical connections: 156 mm / 6 2/16" - 232 mm / 9 2/16"

► Technical information

Production in 24h	46 kg / 101 lbs
Store capacity, up to	20 kg / 44 lbs
Cooling system	A - W
Kind of cube	A-20g
Refrigerant	R290
Standard voltage	220-240 V ~ 50 Hz
Average power consumption	315 W
Fuse	10 A
Electrical consumption	21 kWh/100kg

Water consumption	A: 4 l/kg - 48 gal/100 lbs
	W: 13 l/kg - 156 gal/100 lbs
Sizes (L-P-H mm)	495 - 580 - 797
(L-P-H in)	19 8/16 - 22 13/16 - 31 6/16
Sizes with pack (L-P-H mm)	550 - 630 - 990
(L-P-H in)	21 10/16 - 24 13/16 - 39
Net weight	54 kg / 119 lbs
Gross weight	62 kg / 137 lbs
Finish	AISI 304 stainless steel, scotch brite

All the technical information must be considered at the following conditions:

- Sizes without feet
- Standard Cube (20 g)
- Ambient temperature +21° C
- Water temperature +15° C
- Electrical consumption at +32° C (standard voltage)
- Average power consumption at +43° C (standard voltage)

Models and specifications are subject to change without notice

Rev. 02.1- Issued April 2018



www.bremaice.it
info@bremaice.it

Bim + Data
download

